

VT154/6/2216 Telescopic cylinder

Stempelstang med chrom

6 steps

Total stroke: 2216mm

Max. Workingpressure: 300 bar

Max. Load: 29 ton

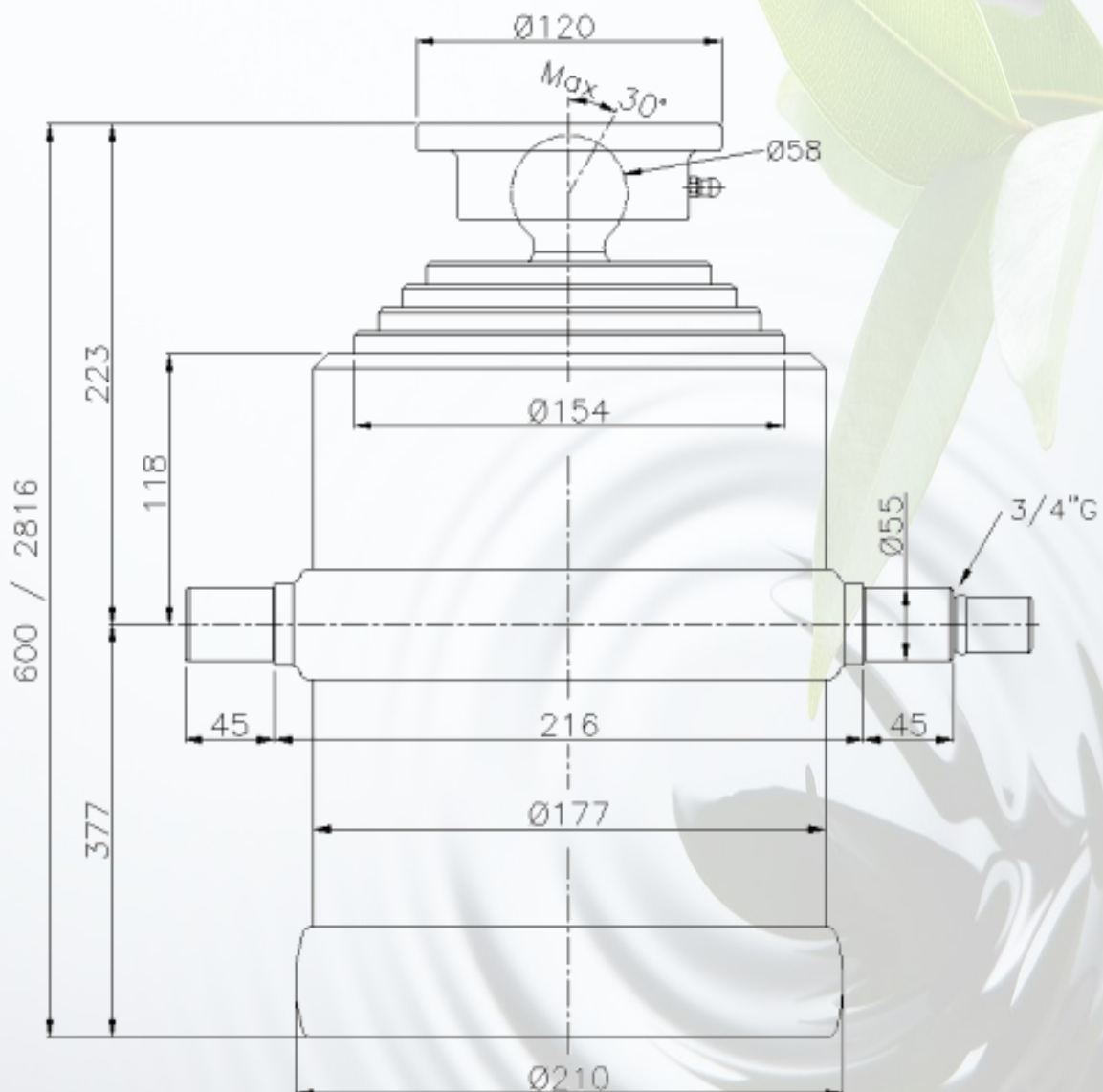

TAON Hydraulic Components ApS are specialists in hydraulic solutions, components and tool.

TAON Hydraulic Components ApS • +45 24 48 84 80 • info@taon.dk • www.taon.dk

© TAON Hydraulic will always help you find the best solution.